

# DF3000

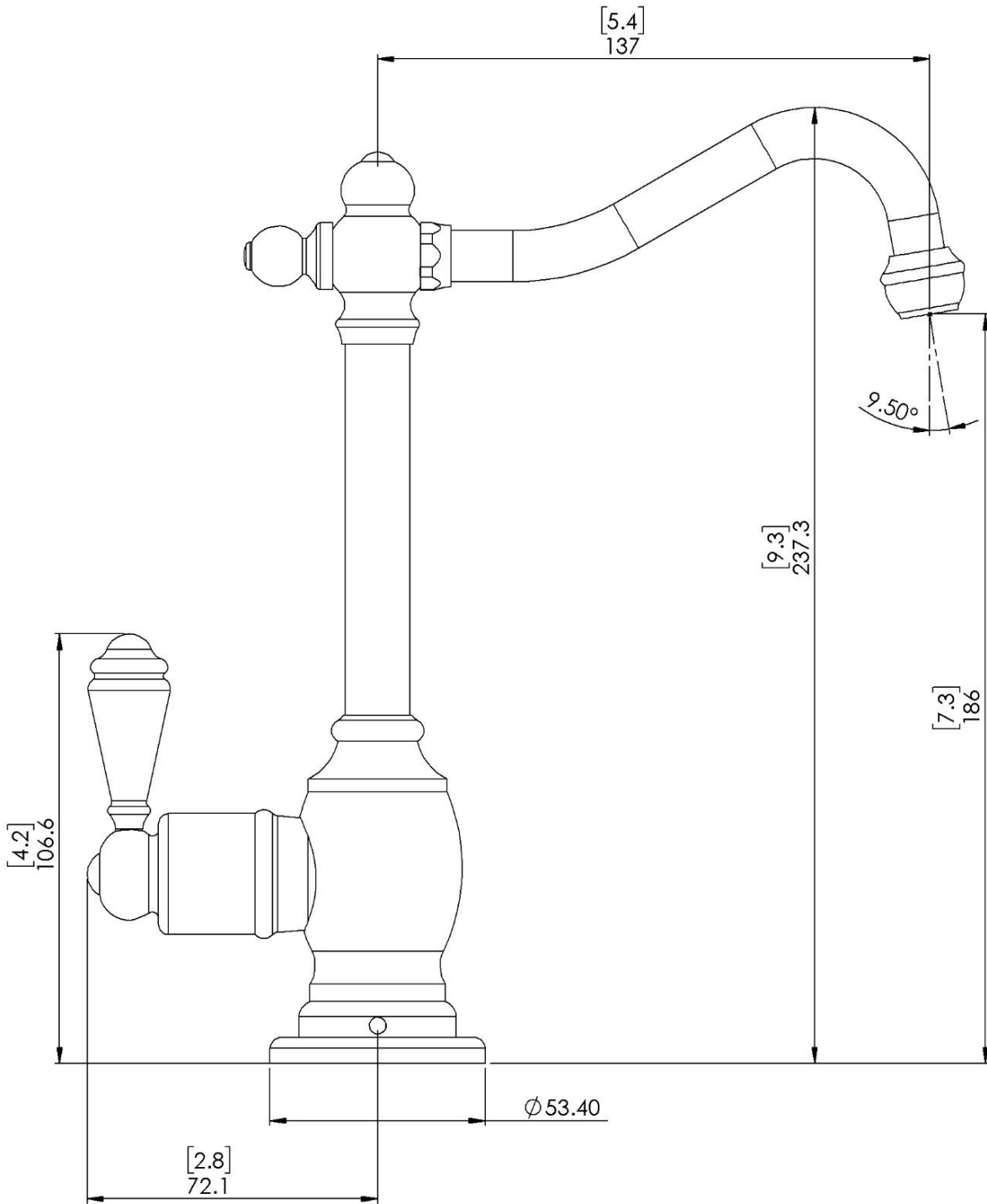

UNIT :  $\frac{[inch]}{mm}$